

FG20451

FIAMM

FIAMM Sealed Power

FG series

FG20451 is a general purpose application battery. Within the FG range Fiamm offer 6V and 12V monoblocs at various amp hour capacities enable the right battery selection for each requirement. FIAMM Sealed Power is a Manufacturer of VRLA batteries; and is supported by a dedicated sales network with market knowledge and experience of small sealed lead acid battery applications.

12 Volt
4.5 Ah



Features

Nominal Voltage	12 Volt
Nominal Capacity	4.5 Ah at 20 hours rate to 1.75 Vpc at 25 °C
Float charging voltage	13.50 - 13.80 V/bloc at 25 °C
Boost charge voltage	14.40 - 15.00 V/bloc at 25 °C
Float voltage compensation	-18mV/°C
Maximum charging current	1.13 A
Case	ABS with HB flammability rate (according UL94)
Internal resistance	39.3 mΩ in full charged condition
Weight	1.58 kg
Dimensions	L x W x H (TH): 90 x 70 x 101 (107)
Operative temperature range	-20 °C to 50 °C

Storage

As batteries lose part of their capacity, during storage, due to self discharge. Fiamm Sealed Power recommends FG range of batteries can be stored for 6 months at an ambient temperature of 20 and 25 °C (see attached graph on reverse). Longer storage requires a recharge. This should be carried out in line with Fiamm Sealed Power recommended method; 2.4 V/cell for no longer than 24 hours at 20 °C

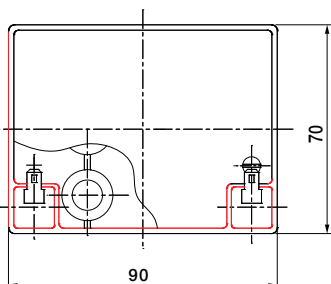
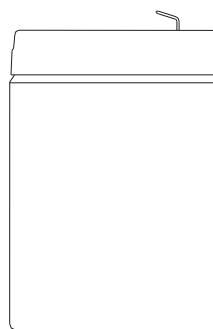
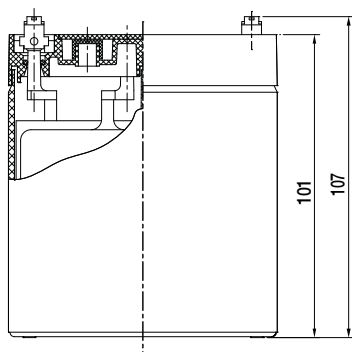

The dimensions have a tolerance of : ± 1.6%

Faston 4.8 mm

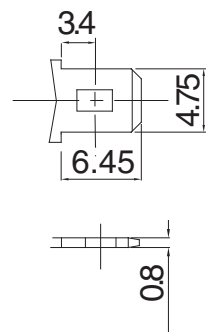



AN30



MH27960

Capacity loss during storage at various temperatures

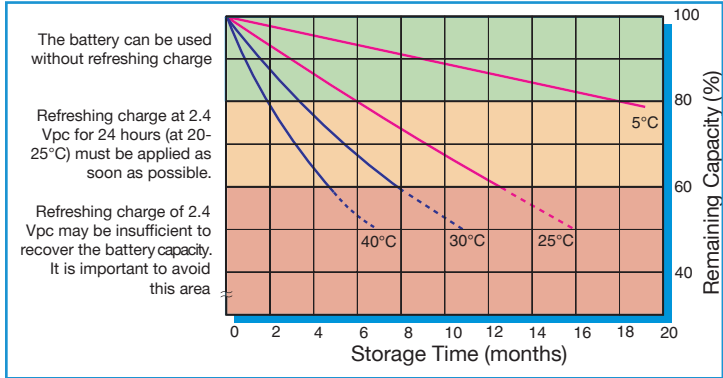

Battery Voltage and Charge Time for Standby Use (at 25°C)

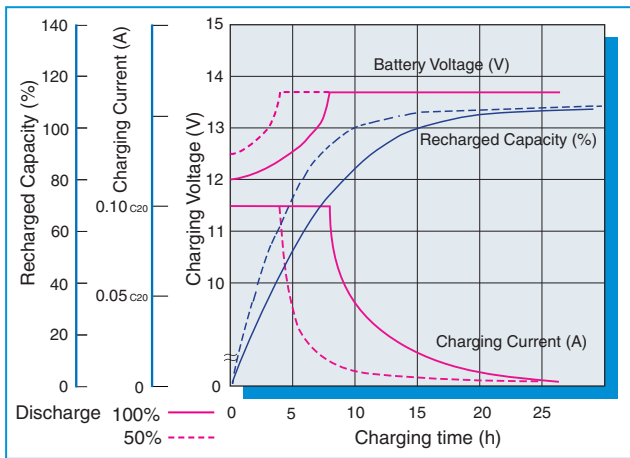

Discharge curves at different current / final voltage (at 25°C)

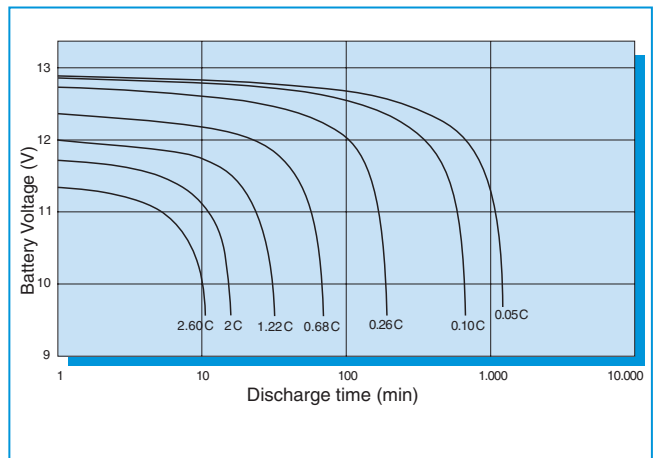

Constant Current discharge table (Amperes)

end voltage	5 min	10 min	15 min	20 min	30 min	45 min	1 hour	2 hour	3 hour	5 hour	10 hour	20 hour
09.60	14.6	10.2	7.66	6.17	4.36	3.16	2.51	1.50	1.11	0.75	0.42	0.23
09.90	14.4	10.1	7.61	6.13	4.33	3.15	2.50	1.50	1.10	0.74	0.42	0.23
10.02	14.2	9.99	7.53	6.07	4.31	3.14	2.49	1.49	1.10	0.74	0.42	0.23
10.20	13.7	9.70	7.38	5.95	4.27	3.12	2.48	1.48	1.09	0.74	0.42	0.23
10.50	12.7	9.11	7.05	5.72	4.19	3.07	2.44	1.46	1.08	0.72	0.41	0.23
10.80	11.8	8.53	6.64	5.40	4.01	2.88	2.30	1.34	0.99	0.68	0.39	0.22

Constant Power discharge table (Watts per bloc)

end voltage	5 min	10 min	15 min	20 min	30 min	45 min	1 hour	2 hour	3 hour	5 hour	10 hour	20 hour
09.60	147	106	81.2	66.3	47.6	35.2	28.2	17.1	12.8	8.65	4.91	2.71
09.90	145	106	80.8	66.1	47.5	35.2	28.2	17.1	12.7	8.65	4.90	2.71
10.02	143	104	80.1	65.5	47.3	35.1	28.2	17.1	12.7	8.61	4.89	2.71
10.20	138	101	78.6	64.3	46.9	34.8	28.0	17.0	12.6	8.58	4.88	2.70
10.50	129	95.4	75.5	62.0	46.2	34.5	27.7	16.9	12.5	8.48	4.83	2.68
10.80	120	89.9	71.5	59.0	44.6	32.5	26.2	15.5	11.6	7.99	4.66	2.63

FIAMM reserves the right to change or revise without notice any information or detail given in this publication